

The Virtual-Link Enhanced Al-Yaseer, A Mechanism Analysis Package for the Undergraduate Classroom

A.R. MANNA, M.A. MANSOUR and M. AKYURT

*Department of Mechanical Design and Production, Faculty of Engineering
King Abdulaziz University, Jeddah, Saudi Arabia.*

ABSTRACT. The magnitude of repetitive work involved in design and analysis is cited, and it is pointed out that much of this pedagogically irrelevant labour can be assigned to the computer. Al-Yaseer, a mechanism analysis software package that was developed at King Abdulaziz University (KAU) specifically for undergraduate teaching, is briefly reviewed.

The concept of a virtual link as an aid in mechanism analysis is reiterated. Kinematic relationships are derived for the first inversion of the slider-crank mechanism, such that it features a flexible crank.

The utility of the concept of a virtual flexible link in enhancing the domain of applicability of Al-Yaseer to a variety of realistic problems in the kinematic as well as the dynamic analysis of mechanisms is demonstrated. Several examples, involving the slider-crank mechanism and its inversions as well as the four bar linkage, are fully worked out.

It is concluded that, bolstered with the concept of a virtual flexible link, Al-Yaseer assumes the role of a modest and yet powerful tool for students and practicing engineers alike in reducing the formidable amount of analysis and design labor to a few input and equivalency statements. It is asserted that, machine cycle analyses hitherto not possible within the framework of a reasonable number of tutorial periods, can now be successfully undertaken during one period; thus enabling suitable interpretation and decision making.

1. Introduction

Traditionally kinematics, and to a large extent, kinetics of mechanisms and machinery are handled at the undergraduate level by the use of graphical and other manual techniques. Typically a given motion is taken up and analyzed repetitively, by using

several different methods. Due to the large volume of computations involved, a given mechanism is characteristically treated at one selected position only, leaving the students with the remark that in an actual design situation a full cycle analysis is a must. This strategy, naturally, is adopted for lack of more powerful tools at this particular level.

Al-Yaseer, a user-friendly software package that was developed at KAU was introduced in prior communications^[1,2]. To use Al-Yaseer, the user partitions the mechanical system under consideration into its "basic linkages". The basic linkages typically comprise the slider-crank mechanism and its inversions as well as the four-bar linkage and its inversions. Al-Yaseer contains, under separate subroutines, kinematic and dynamic relationships for each basic linkage. What is required from the user is the provision of dimensional, kinematic and dynamic input data for the basic linkages. Al-Yaseer then provides the totality of position, kinematic and force fields covering every joint as well as selected other points of interest in the mechanism or machine system.

It is readily conceded that the analysis of mechanisms and machinery becomes trivial in effort when Al-Yaseer is utilized. The user has little more to provide than input and equivalency statements in order to have at his disposal a comprehensive analysis of the entire system. Computation for a complete kinetic cycle of events generally requires less than half an hour on portable/pocket computers. Perhaps the most significant aspect of this process is that the analysis is done in class, by the student himself, using his own computer.

Al-Yaseer is capable of analyzing a variety of mechanisms in the manner outlined above^[1,2]. Solutions are readily obtained when basic linkages are driven by a common crank or when they are arranged in tandem. There is a particular class of mechanisms, however, the straightforward analysis of which eludes Al-Yaseer.

Consider, for example, the double-slider mechanism of Fig. 1. Given the angular velocity of crank AoA , and the relevant geometric information, the motion of ABC and the piston B of the slider-crank $AoAB$ may be readily determined by calling Program 1 of Al-Yaseer. Program 1 determines the motion for a slider-crank mechanism. The motion of member $CCoD$, however, is not as readily computed. This is because the member $CCoD$ does not seem to conform to a basic linkage.

In what follows, we outline the concept of a virtual link. This concept is subsequently utilized alongside Al-Yaseer to analyze several mechanisms, the analysis of which, would not be viable by the original Al-Yaseer.

2. Motion of a Virtual Link

Consider a virtual link L (Fig. 2) that extends from the fixed origin O to a moving point, that has the instantaneous coordinates $X(10)$, $Y(10)$. Assume that $X(10)$, $Y(10)$ and their first and second time derivatives $V(17)$, $V(18)$ and $A(49)$, $A(50)$ exist

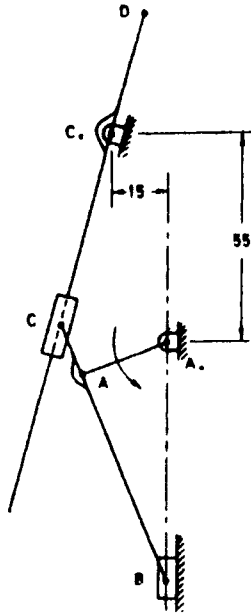

FIG. 1. An indexing mechanism.

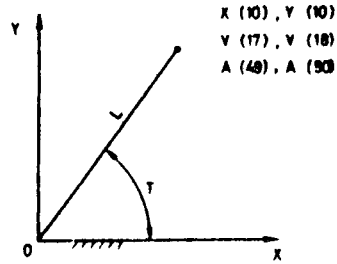

FIG. 2. Virtual link L.

and are known. It follows that

$$\begin{aligned} \tan T &= Y(10) / X(10) \\ L &= X(10) / \cos T \end{aligned}$$

Defining next

$$\begin{aligned} D(5) &= dT / dt & E(5) &= d^2 T / dt^2 \\ D(6) &= dL / dt & E(6) &= d^2 L / dt^2 \end{aligned}$$

It may be shown that^[3]

$$D(6) = V(17) \cos T + V(18) \sin T \tag{1}$$

$$D(5) = (V(18) - D(6) \sin T) / (L * \cos T) \tag{2}$$

$$E(5) = (A(50) \cos T - A(49) \sin T - 2D(6) D(5)) / L \tag{3}$$

$$\begin{aligned} E(6) &= (A(50) + L * D(5)^2 * \sin T - L * E(5) \cos T \\ &\quad - 2D(6) D(5) \cos T) / \sin T \end{aligned} \tag{4}$$

Equations 1 to 4 may be cast in the form of a convenient subroutine, henceforth referred to as Program 5, as follows

```

1 REM Motion of a virtual link
10 X=X(10); Y=Y(10); T=ATN(Y/X); IF X<0 THEN T=T+180
20 L=X/COST; IF T<0 THEN T=T+360
30 IF T-360>0 THEN T=T-360
40 D(6)=V(17)*COST+V(18)*SINT; D(5)=(V(18)-D(6)*SINT)/L/COST
50 E(5)=(A(50)*COST-A(49)*SINT-2*D(6)*D(5))/L
    
```

$$60 \ E(6) = (A(50) - 2 * D(6) * D(5) * \text{COST} + L * D(5)^2 * \text{SINT} - E(5) * \text{COST}) / \text{SINT}; \text{ RETURN}$$

3. Basic Linkages with Flexible Cranks

The concept of a flexible virtual link, as proposed above, can be utilized to analyze a broad class of mechanisms when it is used in connection with Al-Yaseer. Before proceeding with applications, however, it would be instructive to observe the process of incorporation of a flexible link in the subroutines of Al-Yaseer. The typical derivation below for position and kinematic analysis is for the first inversion of the slider-crank mechanism (*FISC*).

3.1 First Inversion of the Slider-Crank (*FISC*)

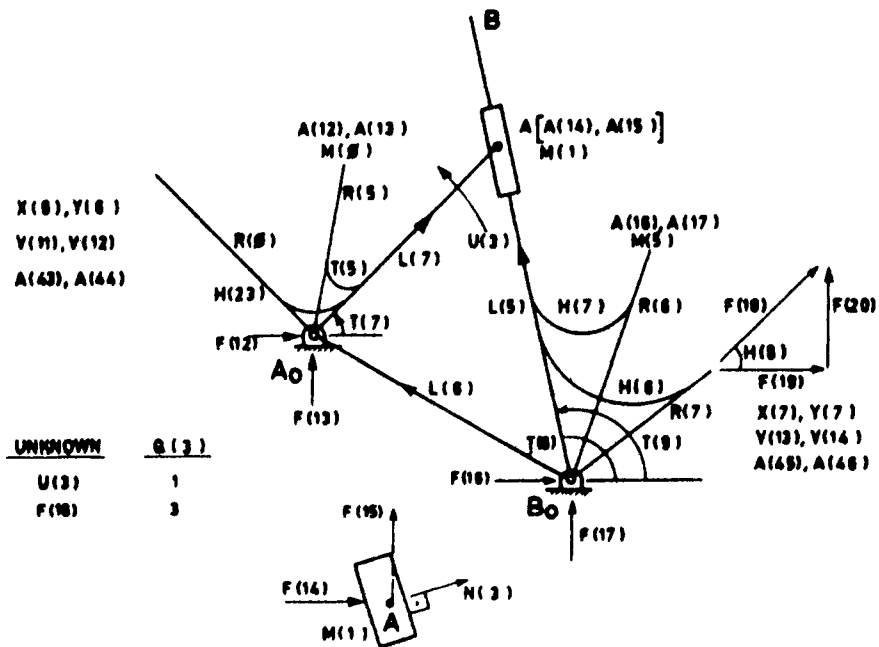

FIG. 3. The first inversion of the slider-crank mechanism (*FISC*).

Figure 3 depicts a general form of *FISC*. The subroutine for *FISC* is stored in Program 3. $L(6)$ and $T(6)$ specify the fixed link, $T(7)$ and $L(7)$ the crank, and $T(9)$ and $L(5)$ the follower. Angular velocity and acceleration of the crank and the follower are given by $W(0)$, $A(0)$ and $W(4)$, $A(4)$, in this order. $R(5)$, $T(5)$ and $R(6)$, $H(7)$ specify the locations of the mass centers for the crank and the follower, respectively. $R(0)$, $H(23)$ and $R(7)$, $H(6)$ locate specific points on these two members for which position, velocity and acceleration data is provided by Program 3.

Force computations are initiated by setting $Z(3)=2$. $F(18)$ and $U(3)$ are the external force and couple that may be determined by specifying $Q(3)$ as one or three. The

reactions $F(12)$, $F(13)$, $F(16)$ and $F(17)$ as well as joint forces $F(14)$, $F(15)$ and $N(3)$ are computed automatically for either value of $Q(3)$. $I(0)$, $I(1)$ and $I(5)$ denote the centroidal mass moment of inertia for the crank, the slider and the follower, respectively.

Referring to Fig. 3, we have for the vector polygon $BoAoA$,

$$\mathbf{L}(6) + \mathbf{L}(7) = \mathbf{L}(5)$$

Writing in component form,

$$L(6) \cos T(6) + L(7) \cos T(7) = L(5) \cos T(9) \quad (5)$$

$$L(6) \sin T(6) + L(7) \sin T(7) = L(5) \sin T(9) \quad (6)$$

whence, for given $L(6)$, $T(6)$, $L(7)$ and $T(7)$ we obtain

$$\tan T(9) = (L(6) \sin T(6) + L(7) \sin T(7)) / (L(6) \cos T(6) + L(7) \cos T(7)) \quad (7)$$

$$\text{and } L(5) = (L(6) \cos T(6) + L(7) \cos T(7)) / \cos T(9) \quad (8)$$

Equations 5 and 6 may be differentiated with respect to time to determine the derivatives $W(4)$ and $A(4)$ of $T(9)$, and $D(4)$ and $E(4)$ of $L(5)$. Note here that AoA is the crank, and hence $T(7)$ and its time derivatives $W(0)$ and $A(0)$ are assumed known. Likewise $T(6)$ and $L(6)$ are constant. $L(7)$, however, will be treated as a flexible crank, and its first and second time derivatives $D(3)$ and $E(3)$ will be assumed known.

Differentiation of Eq. 5 and 6 with respect to time yields,

$$W(4) = (L(7)W(0) \cos T(T(7) - T(9)) + D(3) \sin(T(7) - T(9))) / L(5) \quad (9)$$

$$D(4) = (D(3) \cos T(7) - L(7) W(0) \sin T(7) + L(5) W(4) \sin T(9)) / \cos T(9) \quad (10)$$

A second time derivative of Eq. 5 and 6 yields, after rearrangement,

$$A(4) = (L(7) W(0) \hat{2}^* \sin(T(9) - T(7)) + L(7) A(0) \cos T(T(9) - T(7)) + 2D(3) W(0) \cos(T(9) - T(7)) - E(3) \sin(T(9) - T(7)) - 2D(4) W(4)) / L(5) \quad (11)$$

When incorporated into Program 3 of Al-Yaseer, Eq. 7 to 11 constitute the essentials of the kinematics of *FISC*. Similar derivations may be executed for the general slider-crank mechanism, shown in Fig. 4, and the general four-bar linkage, shown in Fig. 5^[3].

3.2 Slider-Crank Mechanism

The general slider-crank mechanism of Al-Yaseer is shown in Fig. 4. $L(1)$ indicates the eccentricity, $L(2)$ and $L(3)$ the link lengths AoA and AB , respectively, and $T(2)$, $T(3)$ and $T(4)$ are the inclinations of the crank, the connecting rod and the cylinder axis, respectively. All angles are positive when measured from the horizontal x -axis in the Tawafwise (counterclockwise) direction. The first- and second-time derivatives of $T(2)$, $T(3)$, and $L(2)$ are $W(2)$, $A(2)$, $W(3)$, $A(3)$, and $D(0)$, $E(0)$, in this

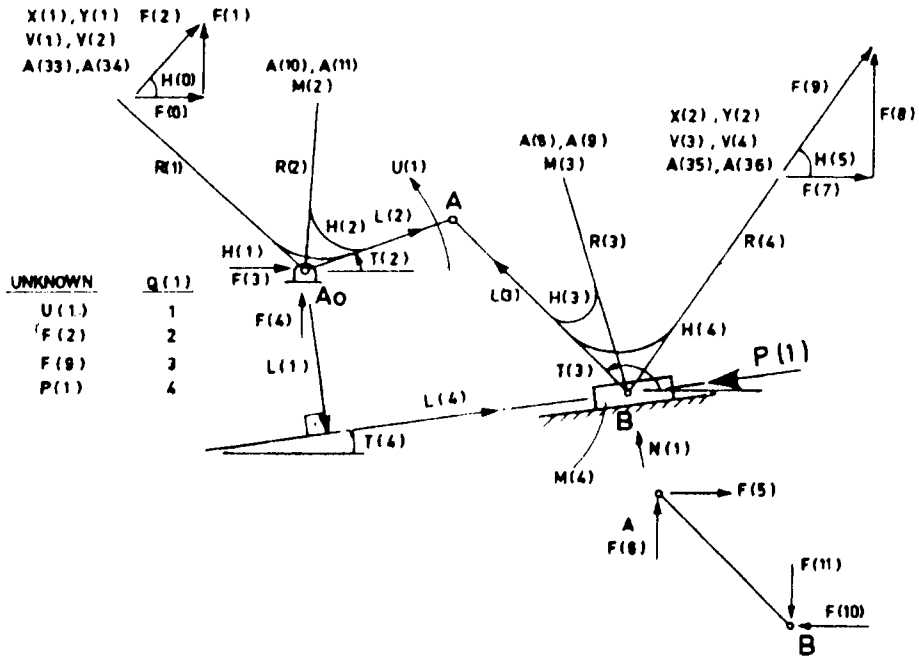

FIG. 4. The general slider-crank mechanism of Al-Yaseer.

order. $R(2)$ and $R(3)$ are used to locate the center of mass of the crank of mass $M(2)$ and the connecting rod of mass $M(3)$, respectively. $H(2)$ and $H(3)$ help locate the respective mass center with respect to $L(2)$ and $L(3)$. $A(10)$ and $A(11)$ depict the x and y components of the acceleration of $M(2)$.

$R(1)$, $H(1)$ and $R(4)$, $H(4)$ help locate any other point of interest on the crank and on the connecting rod, respectively. Considering $R(1)$, $H(1)$ as an example, the x and y coordinates of the point located by $R(1)$, $H(1)$ are $X(1)$, $Y(1)$. Similarly $V(1)$, $V(2)$ and $A(33)$, $A(34)$ yield the x and y components of the velocities and accelerations of the same point.

$P(1)$ designates a force acting on the piston. $F(2)$ is an unknown force acting at a point $R(1)$, $H(1)$ of the crank, and $F(9)$ acts on the connecting rod. Any given or known force on the crank is depicted in component form by $F(0)$ and $F(1)$. $F(7)$ and $F(8)$ are components of a known force acting on the connecting rod. $U(1)$ is a torque, positive as shown, acting on the crank. $F(3)$ and $F(4)$ are components of the resulting reaction at A_0 . $F(5)$, $F(6)$ and $F(10)$, $F(11)$ are joint forces generated at the joints A and B , respectively. $N(1)$ is the normal reaction at the cylinder.

Program 1, where the information on the slider-crank mechanism is stored, as well as the rest of the subroutines of Al-Yaseer, are structured such that the computer does not necessarily run through the entire subroutine each time it is called. Thus if a

static or quasi-static analysis is desired, an internal checking mechanism loops the computation outside the section on kinematics. In fact kinematics will be computed only if a nonzero value is specified to $W(2)$. Force computations are initiated only if $Z(1)$ is set equal to 2 by the user. In this case, a value between one and four needs to be assigned to $Q(1)$ to indicate to the computer what unknown external force or couple is to be solved for, *i.e.*, $F(2)$, $F(9)$, $P(1)$ or $U(1)$. All reactions and joint forces will then be automatically computed irrespective of the value assigned to $Q(1)$. $I(2)$ and $I(3)$ denote the centroidal mass moment of inertia of the crank and the follower, respectively.

3.3 Four-Bar Linkage

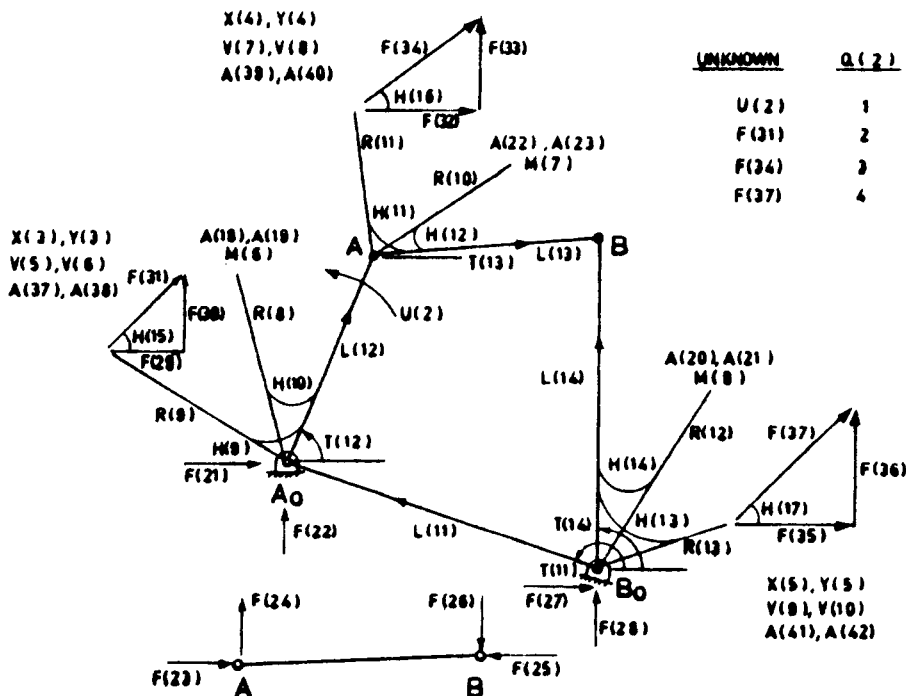

FIG. 5. Master figure for the four-bar linkage of Al-Yaseer.

Figure 5 shows the four-bar linkage A_oABBo in its general form. $L(11)$ is the fixed link, $L(12)$ the crank, $L(13)$ the coupler, and $L(14)$ is the follower. The first- and second-time derivatives of the position angles $T(12)$, $T(13)$, $T(14)$ and crank length $L(12)$ are $W(5)$, $A(5)$, $W(6)$, $A(6)$, $W(7)$, $A(7)$, and $D(2)$, $E(2)$, in this order. The sets $R(8)$, $H(10)$, $R(10)$, $H(12)$ and $R(12)$, $H(14)$, help locate the center of mass of the crank of mass $M(6)$, the coupler of mass $M(7)$ and the follower of mass $M(8)$, respectively. The angles $H(10)$, $H(12)$ and $H(14)$ are positive as shown, and are measured relative to $L(12)$, $L(13)$ and $L(14)$, in this order. Setting $L(10) = 1$ indicates that the mechanism is crossed; otherwise it is uncrossed.

The pairs $R(9)$, $H(9)$, $R(11)$, $H(11)$ and $R(13)$, $H(13)$ help locate any other point of interest on the crank, the coupler and the follower. Thus for a point on the coupler, located at $R(11)$, $H(11)$, Program 2 will determine the x and y components of displacement $X(4)$, $Y(4)$, velocity $V(7)$, $V(8)$ and acceleration $A(39)$, $A(40)$.

$F(31)$, $F(34)$ and $F(37)$ are externally applied unknown forces acting at the locations indicated. $U(2)$ is an external torque acting on the crank. Any external force the value of which is known, and that acts at one of these locations is depicted in component form as $F(29)$, $F(30)$ on the crank, $F(32)$, $F(33)$ on the coupler, and $F(35)$, $F(36)$ on the follower. The resulting reactions at A_0 and B_0 are indicated in component form by $F(21)$, $F(22)$ and $F(27)$, $F(28)$, respectively. $F(23)$, $F(24)$ and $F(25)$, $F(26)$ are forces generated at the joints A and B , in this order. $I(5)$, $I(6)$ and $I(7)$ are the mass moments of inertia about the respective centre of mass in the crank, the coupler and the follower.

Having supplied the basic linkages of Al-Yaseer with the supplemental information on flexible cranks, we are now ready to illustrate some of what is possible with the virtual link.

4. Application Examples

Example 1

Given the mechanism shown in Fig. 6, and that $A_0A = 75$, $AB = BC = BD = 150$, all in mm, and angular velocity of $A_0A = 25$ rad/s Tawafwise and constant, it is desired to determine the position, velocity and acceleration of piston D for a complete revolution of the crank.

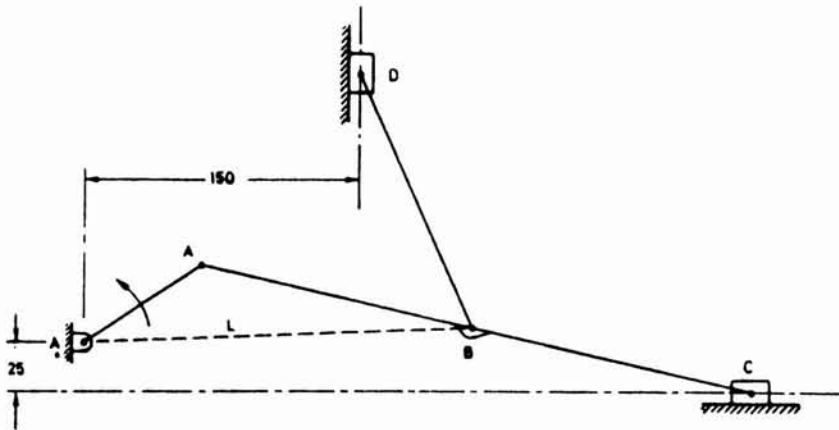

FIG. 6. The mechanism for Example 1.

Solution

Calling Program 1 for A_0ABC with $W(2) = 25$, $L(1) = 25$, $L(2) = 75$, $L(3) = 300$, $T(4) = 0.1$ and $R(4) = 150$ yields, among others, the position $X(2)$, $Y(2)$, the velocity $V(3)$, $V(4)$ and acceleration $A(35)$, $A(36)$ of point B . $H(4)$ is zero.

With the fixed origin at Ao , we may conceive an imaginary link between Ao and B , the motion of which can be determined by calling Program 5. Assigning the virtual link AoB to be the variable crank of the slider-crank mechanism $AoBD$, and calling Program 1 once more completes the solution. Letting $R(4) = 0$ at this step allows us to determine the kinematics of the piston D itself.

We list below the program associated with this solution. The universal dimension statement is to be included in the given form in all AI-Yaseer solutions for convenience; it will not be repeated henceforth.

```

2 CLEAR: DIM F(46), M(11), R(19), H(24), A(53), L(20), T(25), W(10),
Z(5), C(14), U(4), D(6), E(6), X(11), Y(11), V(21), Q(4), N(3), I(11), P(4)
20 FOR QQ = .1 TO 360.1 STEP 15: T(2) = QQ: T(4) = .1: L(1) = 25:
L(2) = 75: L(3) = 300: R(4) = 150: W(2) = 25: A(2) = 0: D(0) = 0: E(0) = 0:
GOSUB PROG 1
30 X(10) = X(2): Y(10) = Y(2): V(17) = V(3): V(18) = V(4): A(49) = A(35):
A(50) = A(36): GOSUB PROG 5
40 L(2) = L: D(0) = D(6): E(0) = E(6): T(2) = T: W(2) = D(5): A(2) = E(5)
50 T(4) = 90.1: L(1) = 150: L(3) = 150: R(4) = 0: GOSUB PROG 1
60 PRINT USING "###.###.##"; QQ; Y(2); V(4); A(36): NEXT QQ
70 END
    
```

Statement 20 defines the input data for the slider-crank mechanism $AoAC$. Step 30 prepares the virtual link data. Step 40 translates the virtual link results into data that is associated with the flexible crank, and step 50 completes the data for the second slider-crank mechanism ($AoBD$). Figure 7 summarizes the results.

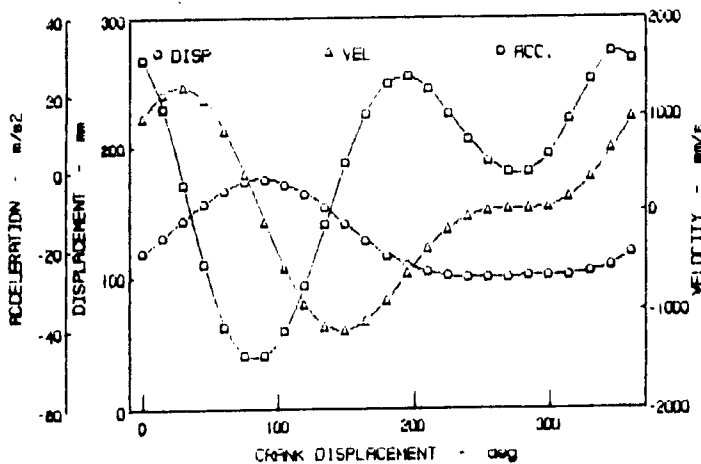

FIG. 7. Kinematics of piston D in Example 1.

If it were desired to undertake a dynamic analysis for the above mechanism, the calling program would maintain its brevity and essentially simple features. It is im-

portant to note, however, that the units would then have to be in terms of kg, m, and s, as illustrated in the next example.

Example 2

The mechanism shown in Fig. 8 is used for a churning operation such that the force acting on the plunger D is given by

$$P = 650 * (\text{velocity of } D)^2$$

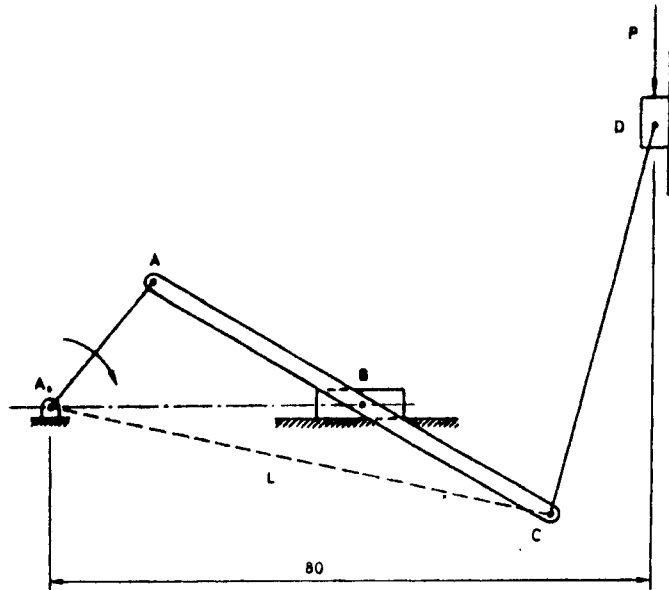

FIG. 8 The churning mechanism.

It is desired to find the necessary input torque on AoA , the normal reaction at B , and the magnitude of the bearing reaction at Ao for a uniform clockwise input speed of 8 rad/s. Neglect all masses. $AoA = 21$, $AB = 32$, $BC = 29$, and $CD = 54$, all in mm.

Solution

Kinematics of the slider-crank mechanism $AoAC$ are determined by calling Program 1 with $R(4) = BC$ (see step 10 below). The auxiliary link AoC is next computed in steps 20 and 30. Velocity of the plunger D of the slider-crank mechanism $AoCD$ is computed by calling Program 1 and setting $R(4) = 0$ (step 40).

The plunger force P and its direction are determined in step 50. A force computation is invoked in step 60 by setting $Z(1) = 2$ and $Q(1) = 1$. Calling Program 1 for $AoCD$ results in the determination of the components $F(5)$ and $F(6)$ of the internal force at C .

The internal force at C of $AoCD$ is next (step 70) applied on $AoABC$ as components $F(7)$ and $F(8)$ of an external force. Calling Program 1 completes the solution. The calling program is listed below, and the results are summarized in Fig. 9.

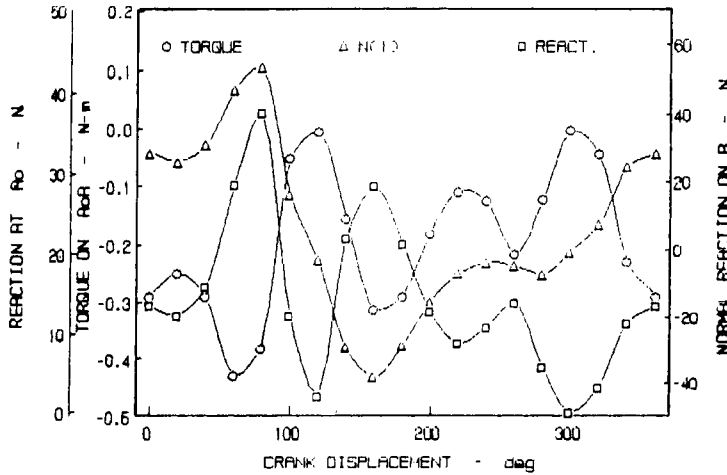

FIG. 9. Variation of input torque and reactions with crank position in the mechanism of Example 2.

```

10 FOR QQ = 360.1 TO .1 STEP - 20: GOSUB 100: GOSUB PROG 1
20 X(10) = X(2): Y(10) = Y(2): V(17) = V(3): V(18) = V(4): A(49) = A(35):
   A(50) = A(36): GOSUB PROG 5
30 L(2) = L: D(0) = D(6): E(0) = E(6): T(2) = T: W(2) = D(5): A(2) = E(5)
40 T(4) = 90.1: L(1) = .08: L(3) = .054: R(4) = 0: GOSUB PROG 1
50 IF V(4) > 0 THEN P(1) = 650 * V(4) ^ 2 ELSE P(1) = -650 * V(4) ^ 2
60 Z(1) = 2: Q(1) = 1: GOSUB PROG 1
70 P(1) = 0: F(7) = -F(5): F(8) = -F(6): GOSUB 100: GOSUB PROG 1
80 LPRINT USING "#####.#"; QQ; U(1); N(1); SQR(F(3) ^ 2 +
   F(4) ^ 2): NEXT QQ: END
100 T(2) = QQ: L(1) = 0: T(4) = .1: L(2) = .021: D(0) = 0: E(0) = 0: W(2) = -8:
   A(2) = 0: L(3) = .032: R(4) = .029: H(4) = 180: RETURN
    
```

Example 3

Crank AoA of the indexing mechanism shown in Fig. 1 runs at a constant tawaf-wise speed of 30 rad/s. It is desired to determine the inclination, angular velocity and angular acceleration of output member $CCoD$ as well as the x coordinate of point D over a complete cycle. $AoA = 25$, $AB = 60$, $AC = 15$, and $CoD = 35$ mm.

Solution

Kinematics of the slider-crank mechanism $AoAB$ is readily obtained by referring to Fig. 4 (see steps 3010 to 3030 below). Setting $R(4) = 60 + 15$ and $H(4) = 0$ essentially determines the kinematics of point C .

A virtual link AoC is computed in 3040 to be used as the flexible crank of the $FISC$

AoCCoD. Step 3020 computes the constants $L(6)$ and $T(6)$ (see Fig. 3), and step 3050 translates the virtual link in terms of the crank *AoC*. Calling of Program 3 in step 3050 completes the solution. Figure 10 displays the results.

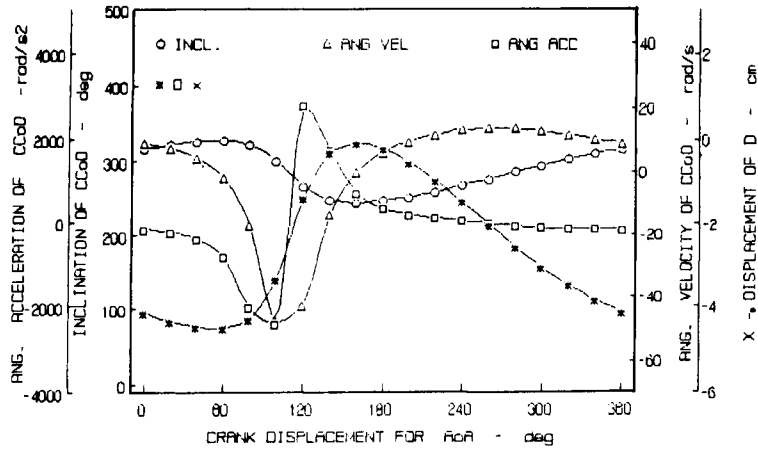

FIG. 10. Kinematics of the mechanism of Example 3.

```

3010 T(4) = -90.1: L(2) = 2.5: L(3) = 6: W(2) = 30: R(4) = 7.5: R(7) = 3.5:
      H(6) = 180
3020 L(6) = SQR(1.5^2 + 5.5^2): T(6) = ATN(-5.5/1.5)
3030 FOR T(2) = .1 TO 360.1 STEP 20: GOSUB PROG 1
3040 X(10) = X(2): Y(10) = Y(2): V(17) = V(3): V(18) = V(4): A(49) =
      A(35): A(50) = A(36): GOSUB PROG 5
3050 L(7) = L: D(3) = D(6): E(3) = E(6): T(7) = T: W(0) = D(5): A(0) =
      E(5): GOSUB PROG 3
3060 LPRINT USING "####.#"; T(2); T(9); W(4); A(4); X(7): NEXT
      T(2): END

```

Example 4

Crank *AoA* of the film transport mechanism displayed in Fig. 11 runs at a uniform tawafwise speed of 35 rad/s. It is required to find the angular velocity and angular acceleration of member *DE* as well as the horizontal component of the velocity and acceleration of point *E* over a full cycle. $AoA = 6.5$, $AB = 28$, $BBo = 14$, $AC = 15$, $CD = 5.5$, $DE = 11.5$, $DH = 31.5$, and $HHo = 17.5$, all in mm.

Solution

AoABBo forms a four-bar linkage. With reference to the four-bar linkage master figure of Al-Yaseer shown in Fig. 5, statements 4020 to 4040 of the program below express the input data for *AoABBo*. $R(11)$ and $H(11)$ are selected for the determination of the kinematics of point *D*. $L(10) = 0$ in step 4030 indicates that *AoABBo* is not crossed.

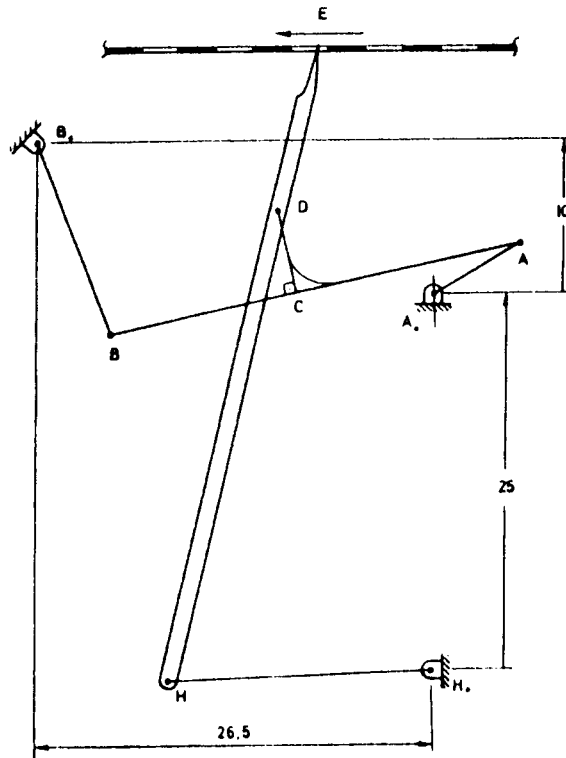

FIG. 11. A mechanism for the transport of film.

```

4020 FOR QQ = .1 TO 360.1 STEP 20: T(12) = QQ: W(5) = 35: A(5) = 0:
      D(2) = 0: E(2) = 0: L(12) = 6.5: L(13) = 28: L(14) = 14: L(11) =
      SQR(26.5^2 + 10^2): T(11) = ATN(-10/26.5)
4030 R(11) = SQR(15^2 + 5.5^2): H(11) = -ATN(5.5/15): L(10) = 0
4040 GOSUB PROG 2
4050 X(10) = X(4): Y(10) = Y(4): V(17) = V(7): V(18) = V(8): A(49) =
      A(39): A(50) = A(40): GOSUB PROG 5
4060 L(12) = L: D(2) = D(6): E(2) = E(6): T(12) = T: W(5) = D(5): A(5) =
      E(5)
4070 L(13) = 31.5: L(14) = 17.5: L(11) = 25: T(11) = 90.1: R(11) = 11.5:
      H(11) = 180: L(10) = 1
4080 GOSUB PROG 2: LPRINT USING "#####.#":QQ; W(6); A(6);
      V(7); A(39) : NEXT QQ : END

```

Steps 4050 and 4060 define the virtual link AD and then translate it into the flexible crank AoD of the four-bar linkage $AoDHHo$. Step 4070 supplies the rest of the information on $AoDHHo$, including the fact that it is crossed ($L(10) = 1$).

The results are displayed in Fig. 12.

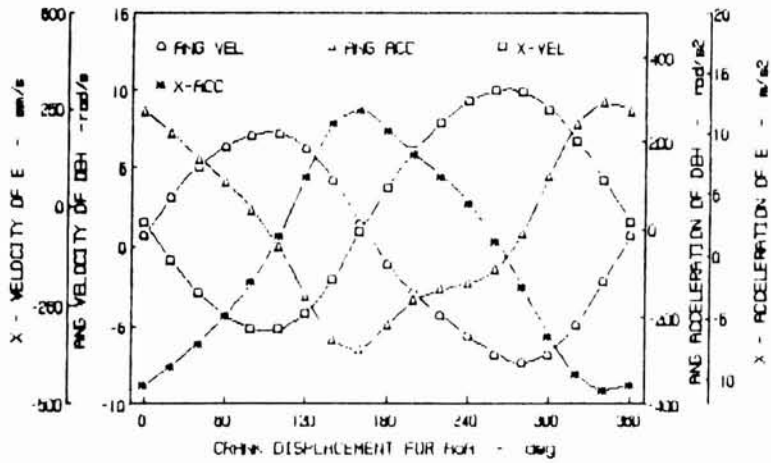

FIG. 12. Kinematics of the film transport mechanism of Example 4.

Example 5

Crank A_0A of the double-toggle jaw crusher shown in Fig. 13 runs at a uniform

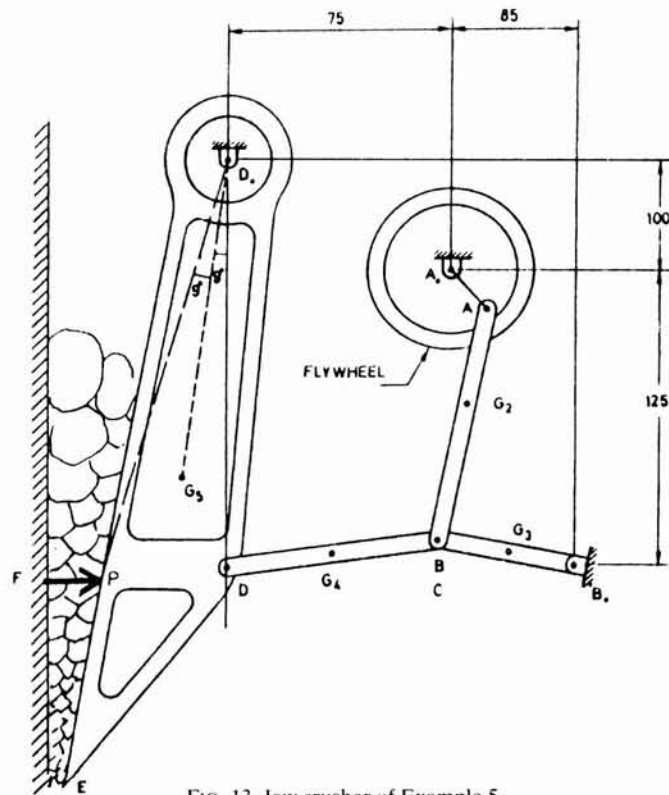

FIG. 13. Jaw crusher of Example 5.

speed of 22 rad/s clockwise. Determine the crank torque, and the bearing reactions at B_o and A_o over a complete cycle, given that

length (cm)	mass (kg)	I (kg-m ²)	dist. to CM
$A_oA = 7.5$	200 (incl. flywheel)	156	$A_oG = 0$
$AB = AC = 120$ $BC = 20$	30	18	$AG2 = 50$
$B_oB = 85$	15	3.7	$B_oG3 = 35$
$CD = 120$	35	28	$CG4 = 40$
$D_oD = 245$	180	435	$D_oG5 = 150$
$D_oF = 250$			

The direction of the equivalent crushing force F (in newtons) is normal to the imaginary line D_oD and the force is applied at point P such that

$$F = 500/(T(14) + 100.5)^3 \quad \text{whenever } W(7) < 0$$

$$F = 0 \quad \text{otherwise.}$$

Solution

Kinematics of the four-bar linkage A_oABBo is readily determined by specifying the appropriate magnitudes (see Fig. 5). This is carried out in steps 5010 and 5100 to 5120 below. Note that A_oABBo is crossed. Steps 5020 and 5030 define a virtual link as the flexible crank of the second four-bar linkage A_oCDD_o . Steps 5200 to 5220 provide the rest of the data for this uncrossed mechanism.

```

5010 FOR QQ = 360.1 TO .1 STEP -20: GOSUB 5100: Z(2) = 0: GOSUB
      PROG 2
5020 X(10) = X(4): Y(10) = Y(4): V(17) = V(7): V(18) = V(8): A(49) =
      A(39): A(50) = A(40): GOSUB PROG 5
5030 L(12) = L: D(2) = D(6): T(12) = T: W(5) = D(5): A(5) = E(5): GOSUB
      PROG 2
5040 IF W(7) < 0 THEN F = 500/(T(14) + 100.5)^3 ELSE F = 0
5050 T = T(14) + 90: F(35) = F*COST: F(36) = F*SINT: Z(2) = 2: Q(2) = 1:
      GOSUB PROG 2
5060 F(35) = 0: F(36) = 0: F(32) = -F(23): F(33) = -F(24): GOSUB 5100:
      GOSUB PROG 2
5070 PRINT USING"#####.##";QQ: U(2): SQR(F(27)^2 = F(28)^2):
      SQR(F(21)^2 = F(22)^2): F(32) = 0: F(33) = 0: NEXT QQ
5080 END
5100 L(11) = SQR(.85^2 + 1.25^2): T(11) = ATN(1.25/-.85) + 180: L(12) =
      .075: D(2) = 0: E(2) = 0: T(12) = QQ: W(5) = -22: A(5) = 0
5110 L(10) = 1: L(13) = 1.2: L(14) = .85: M(6) = 200: I(6) = 156: M(7) = 30:
      R(10) = .5: H(12) = 0: I(7) = 18
5120 M(8) = 15: R(12) = .35: I(8) = 3.7: R(11) = 1.2: H(11) = 0: RETURN
5200 L(10) = 0: L(11) = SQR(1 + .75^2): T(11) = ATN(-1/.75): L(13) = 1.2:

```

$L(14) = 2.45$; $M(6) = 0$; $I(6) = 0$; $M(7) = 35$
 5210 $R(10) = .4$; $H(12) = 0$; $R(11) = 0$; $I(7) = 28$; $M(8) = 180$; $R(12) = 1.5$;
 $H(14) = 9$; $I(8) = 435$; $R(13) = 2.5$; $H(13) = 18$; RETURN

When Program 2 is called at step 5030, angular velocity of DoD becomes available, such that the external force F and its components may be computed (steps 5040, 5050). $Z(2)$ is set to 2 at this stage for force computation in $AoCDDo$. Calling of Program 2 yields, among others, the internal forces at C .

Step 5060 recognizes the equivalency of forces on adjoining members at C , and supplies the internal force just determined as an external force acting on $AoABBo$. A further calling of Program 2 completes the solution.

Note in the subroutines 5100 and 5200 that whenever the same member appears in both subroutines, masses and moments of inertias are cited in only one subroutine in order to avoid double counting. The results of the computation are summarized in Fig. 14.

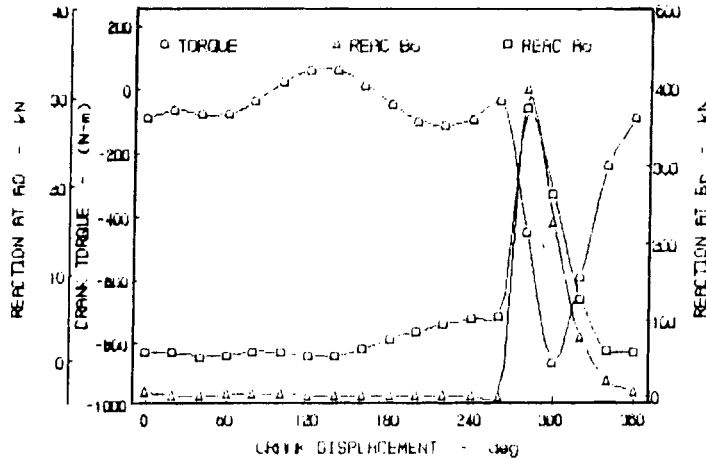

FIG. 14. Crank torque and main reactions in the crusher.

5. Discussion and Conclusion

It is observed from the above presentation that the concept of a virtual, flexible link decisively enhances the power and adaptability of Al-Yaseer. Compounded with a virtual link, Al-Yaseer can be utilized to analyze in detail realistic and complex machine systems. Some of the possibilities are demonstrated in the examples presented above. Applications to kinematically complex mechanisms will be developed and treated elsewhere. In all cases it is witnessed that the user-supplied calling programs are characterized by brevity.

It is concluded that the introduction of Al-Yaseer as a tool in teaching mechanisms and dynamics of machinery makes it possible to considerably reduce the redundant work in analysis and design. Bolstered with the concept of a virtual flexible link, Al-

Yaseer assumes the role of a modest and yet powerful tool for students and practicing engineers alike in reducing the formidable amount of analysis and design labor to a few input and equivalency statements. One of the authors has witnessed that machine cycle analyses hitherto not possible within the framework of a reasonable number of tutorial periods can now be successfully undertaken by the student during one period, thus enabling suitable interpretation and decision making.

List of Symbols

$A(i)$	Second-time derivative of $T(i)$.
$B(i)$	Constant or expression.
$C(i)$	Constant or expression.
$D(i)$	First-time derivative of length or inclination of a flexible member.
$E(i)$	Second-time derivative of length or inclination of a flexible member.
$F(i)$	Unknown force acting at a point, Component of a force in a given direction, Component of joint force in a given direction, or Component of a reaction force in given direction.
$FISC$	First inversion of the slider-crank mechanism.
G	Gravitational acceleration.
$H(i)$	Angular location.
$I(i)$	Centroidal mass moment of inertia of member i .
$L(i)$	Length of link i , or radial distance.
$L(10)$	Indicates whether a four-bar linkage is crossed or not.
$M(i)$	Mass of member i .
$N(i)$	Normal reaction on a slider or piston.
$P(1)$	Force acting on the face of a piston.
$Q(i)$	Dummy variable used for selecting the mode of force computation.
$R(i)$	Radial distance.
$T(i)$	Inclination of member i , as measured from the positive x -axis.
t	Time.
tw	Tawafwise (counterclockwise).
$U(i)$	Torque acting on a member.
$V(i)$	Component of linear velocity in a certain direction.
$W(i)$	First-time derivative of $T(i)$.
$X(i)$	x -component of displacement.
$Y(i)$	y -component of displacement.
$Z(i)$	Dummy variable that is used for choosing between alternatives of analysis subroutines.

References

- [1] **Mannaa, A.R., Mansour, M.A. and Akyurt, M.**, Mechanism analysis by the aid of Al-Yaseer, *Proc. 10th National Computer Conf., Feb. 28-March 3, KAU, Jeddah*, Sci. Publ. Center, **2**: 857-870 (1988).
- [2] **Nahas, M.N., Mohamed, A.S., Akyurt, M. and El-Kalay, A.K.**, Windmills with articulated blades, *Energy* **13** (3): 275-280 (1988).
- [3] **Manna, A.R., Dehlawi, F. and Akyurt, M.**, Kinematic analysis via virtual links, *Computers in Industry* **10**: 261-266 (1988).

الوصلة الافتراضية تعزز برنامج اليسير - مجموعة تحاليل آلية للدراسات الجامعية

عبد الرؤوف محمد مناع ، محمد علي منصور و محمد أكبورت
قسم التصميم الميكانيكي وهندسة الإنتاج ، كلية الهندسة ، جامعة الملك عبد العزيز
جدة - المملكة العربية السعودية .

المستخلص . تم في هذا البحث استعراض مقدار العمل المتكرر المتعلق بعملية التصميم والتحليل . وقد تمت الإشارة إلى أن كثيراً من الجهد المبذول في عملية التدريس لاصلة له بالعملية التعليمية ، وأن بالإمكان إسناده إلى الحاسب الآلي . تم هنا ، باختصار ، استعراض برنامج « اليسير » - مجموعة برامج حاسب آلي لتحليل الآليات - والذي طُوّر في جامعة الملك عبد العزيز خصيصاً للتدريس الجامعي .

وتم بحث مفهوم الوصلة الافتراضية كعنوانٍ في تحليل الآليات ، كما تم استنباط العلاقات الحركية للعكسه الأولى لآلية المرفق المنزلق بحيث تعطى ملامح المرفق المرن .

وقد تم إثبات فائدة مفهوم الوصلة الافتراضية المرنة في تعزيز مجال تطبيق برنامج اليسير في مختلف المشاكل الواقعية في التحليل الكينماتي الدينامي للآليات . كما تم أيضاً استعراض العديد من الأمثلة المتصلة بآلية المرفق المنزلق وانعكاساته ، وكذا وصلة القضبان الأربعة . هذا وقد ثبت أن برنامج اليسير - مدعماً بمفهوم الوصلة الافتراضية المرنة - يلعب دوراً متواضعاً ، ولكنه وسيلة قوية لمساعدة الطلاب ، وكذا المهندسين الممارسين - على السواء - في تقليل كمية العمل الهائل والمضني في التحليل والتصميم ، وتحويلهما إلى عبارات إدخال قليلة متكافئة . وحتى الآن ، لم يكن من الممكن تحليل دورة المكنة في إطار عدد مناسب من فترات التدريب ، ولكن باستخدام برنامج اليسير ، أمكن إنجاز هذا التحليل بنجاح خلال دورة تدريبية واحدة فقط ، مما جعل الإيضاح واتخاذ القرار مناسبين ويسيرين .